

# Preparing Samples for Sequencing Genomic DNA

## Topics

- 3 Introduction
- 5 Kit Contents and Equipment Checklist
- 7 Fragment the Genomic DNA
- 10 Perform End Repair
- 11 Add 'A' Bases to the 3' End of the DNA Fragments
- 12 Ligate Adapters to DNA Fragments
- 13 Purify Ligation Products
- 15 Enrich the Adapter-Modified DNA Fragments by PCR
- 16 Validate the Library

This publication and its contents are proprietary to Illumina, Inc., and are intended solely for the contractual use of its customers and for no other purpose than to operate the system described herein. This publication and its contents shall not be used or distributed for any other purpose and/or otherwise communicated, disclosed, or reproduced in any way whatsoever without the prior written consent of Illumina, Inc.

For the proper operation of this system and/or all parts thereof, the instructions in this guide must be strictly and explicitly followed by experienced personnel. All of the contents of this guide must be fully read and understood prior to operating the system or any of the parts thereof.

FAILURE TO COMPLETELY READ AND FULLY UNDERSTAND AND FOLLOW ALL OF THE CONTENTS OF THIS GUIDE PRIOR TO OPERATING THIS SYSTEM, OR PARTS THEREOF, MAY RESULT IN DAMAGE TO THE EQUIPMENT, OR PARTS THEREOF, AND INJURY TO ANY PERSONS OPERATING THE SAME.

Illumina, Inc. does not assume any liability arising out of the application or use of any products, component parts, or software described herein. Illumina, Inc. further does not convey any license under its patent, trademark, copyright, or common-law rights nor the similar rights of others. Illumina, Inc. further reserves the right to make any changes in any processes, products, or parts thereof, described herein without notice. While every effort has been made to make this guide as complete and accurate as possible as of the publication date, no warranty or fitness is implied, nor does Illumina accept any liability for damages resulting from the information contained in this guide.

**Illumina, Solexa, Array of Arrays, BeadArray, BeadXpress, CSPro, DASL, GoldenGate, Infinium, IntelliHyb, iSelect, Oligator, Sentrix, VeraCode, and Making Sense Out of Life** are registered trademarks or trademarks of Illumina, Inc. Other brand and product names mentioned herein may be trademarks or registered trademarks of their respective owners.

© 2007 Illumina, Inc. All rights reserved.

\*Phusion is a trademark of Finnzymes Oy. Notice to purchaser: The purchase price of this product includes a limited, non-transferable license under U.S. and foreign patents owned by BIO-RAD Laboratories, Inc., to use this product. No other license under these patents is conveyed expressly or by implication to the purchaser by the purchase of this product.

# Introduction

This protocol explains how to prepare libraries of genomic DNA for analysis on the Illumina Cluster Station and Genome Analyzer. You will add adapter sequences onto the ends of DNA fragments to generate the following template format:

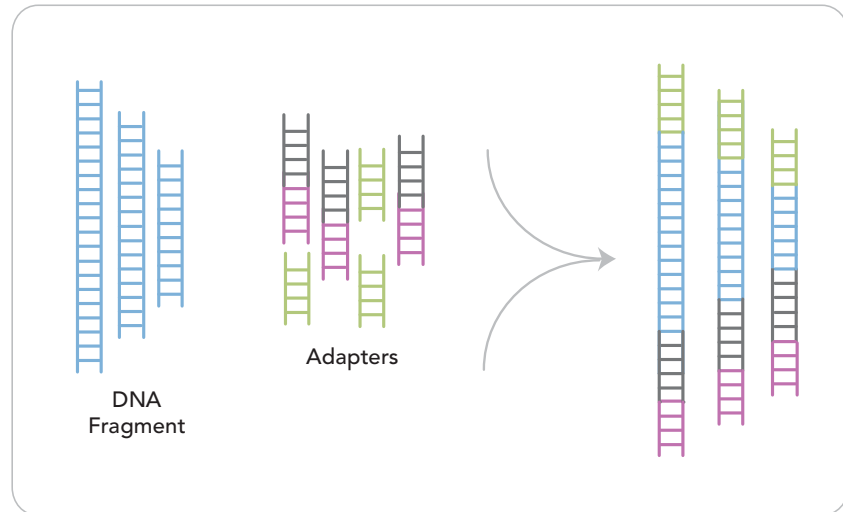

*Figure 1* Fragments after Sample Preparation

The Adapter 1 and Adapter 2 sequences correspond to the two surface-bound amplification primers on the flow cells used in the Cluster Station.

## Workflow

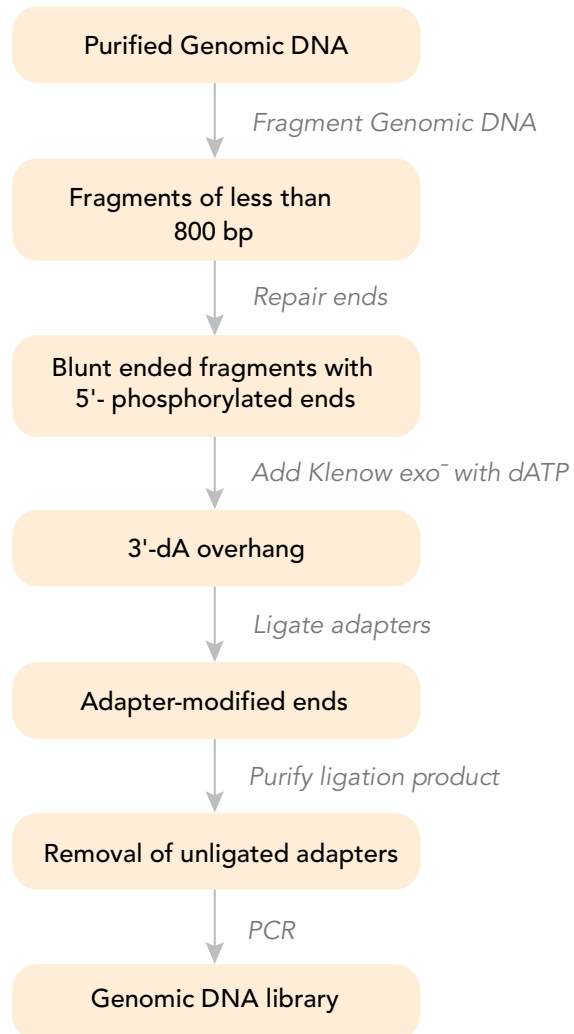

Figure 2 Sample Preparation Workflow

## Kit Contents and Equipment Checklist

Check to ensure that you have all of the reagents identified in this section before proceeding to sample preparation.

### Genomic Sample Prep Kit, Box 1

Store at -20°C

This box is shipped at -80°C. As soon as you receive it, store the following components at -20°C.

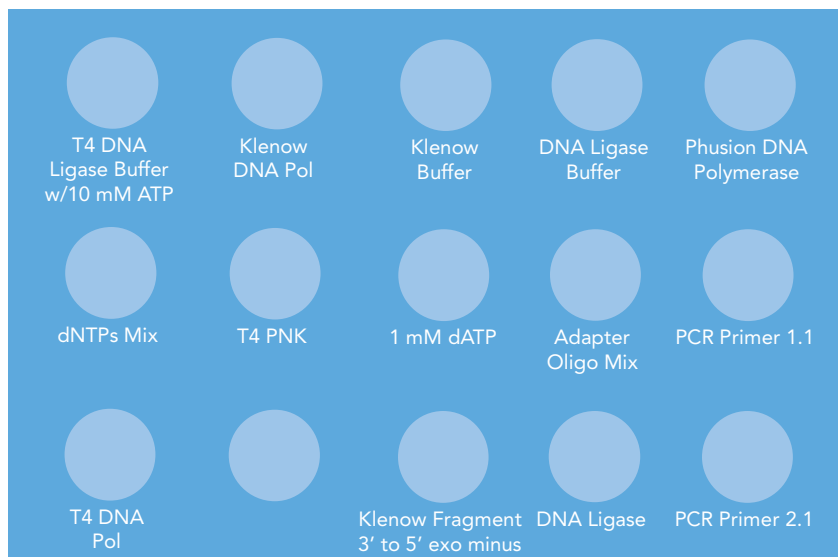

illumina Part #	Description
1000513	10 mM dNTPs Mix
1000514	T4 DNA Polymerase
1000515	Klenow DNA Polymerase
1000519	T4 PNK
1000520	1 mM dATP
1000521	Genomic Adapter Oligo Mix
1000522	DNA Ligase
1000523	2X DNA Ligase Buffer
1000524	Phusion* DNA Polymerase (Finnzymes Oy)
1000534	T4 DNA Ligase Buffer with 10 mM ATP
1000535	Klenow Buffer

ILLUMINA PART #	DESCRIPTION
1000536	Klenow Fragment (3' to 5' exo minus)
1000537	PCR Primer 1.1
1000538	PCR Primer 2.1

## Genomic Sample Prep Kit, Box 2

### Store at Room Temperature

This box is shipped at room temperature. Store the following components at room temperature.

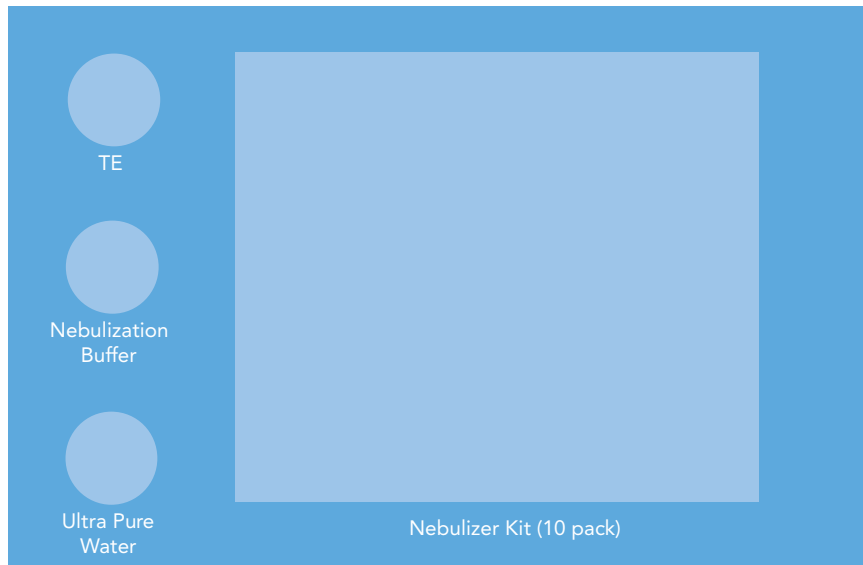

ILLUMINA PART #	DESCRIPTION
1000465	TE Buffer
1000466	Nebulization Buffer
1000467	Ultra Pure Water
1000541	Nebulizer Kit (10 each)

## Equipment Checklist

Check to ensure that you have all of the necessary user-supplied equipment before proceeding to sample preparation.

- ▶ Benchtop microcentrifuge
- ▶ Benchtop centrifuge with swing-out rotor
- ▶ Dark Reader transilluminator
- ▶ Disposable scalpels
- ▶ Electrophoresis unit
- ▶ Gel trays and tank
- ▶ Thermal cycler or heat block

## Fragment the Genomic DNA

This protocol fragments the genomic DNA using a nebulization technique, which fragments DNA to less than 800 bp in minutes using a cost-effective, disposable device. Nebulization generates double-stranded DNA fragments that are blunt-ended or comprised of 3' or 5' overhangs.

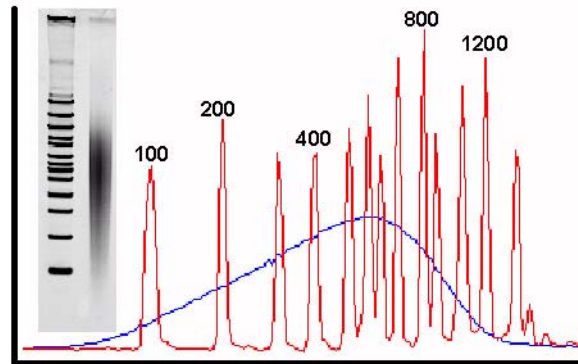

Figure 3 Fragment Genomic DNA

### Consumables Illumina-Supplied

- ▶ Nebulizers (box of 10 nebulizers and vinyl accessory tubes)
- ▶ Nebulization buffer (7 ml)

### User-Supplied

- ▶ QIAquick PCR Purification Kit (QIAGEN, part # 28104)
- ▶ Purified DNA (1–5 µg, 5 µg recommended)  
DNA should be as intact as possible, with an OD<sub>260</sub>/OD<sub>280</sub> ratio of 1.8–2
- ▶ Compressed air of at least 32 psi
- ▶ Clamp (1 per nebulizer) (Aldrich, part # Z22417-0-50EA)
- ▶ TE Buffer (10 mM Tris, 1 mM EDTA)
- ▶ PVC tubing
  - Fisher Scientific, catalog # 14-176-102
  - Nalgene Labware, catalog # 8007-0060

ID (in)	OD (in)	Wall (in)	Length
1/4	3/8	1/16	1 meter



**CAUTION**

If you intend to nebulize DNA that could possibly contain any pathogenic sequences such as pathogenic viral DNA, perform the nebulization process under containment conditions (e.g., a biosafety cabinet) to prevent exposure to aerosols.

## Procedure



NOTE

If you are not familiar with this shearing method, Illumina recommends that you perform this procedure on test samples before proceeding with your sample DNA.

1. Remove a nebulizer from its plastic packaging and unscrew the blue lid.
2. Using gloves, remove a piece of vinyl tubing from its packaging and slip it over the central atomizer tube. Push the tubing all the way to the inner surface of the blue lid.

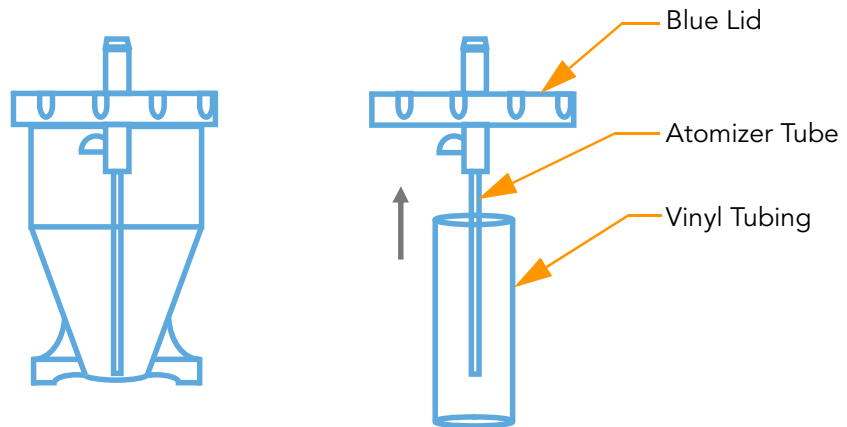

*Figure 4* Assemble the Nebulizer

3. Add 1–5  $\mu\text{g}$  of purified DNA in a total volume of 50  $\mu\text{l}$  of TE buffer to the nebulizer.
4. Add 700  $\mu\text{l}$  nebulization buffer to the DNA and mix well.
5. Screw the lid back on, finger-tight.
6. Chill the nebulizer containing the DNA solution on ice.
7. Connect the compressed air source to the inlet port on the top of the nebulizer with the PVC tubing. Secure with the small clamp. Make sure that the tubing is flush with the port.



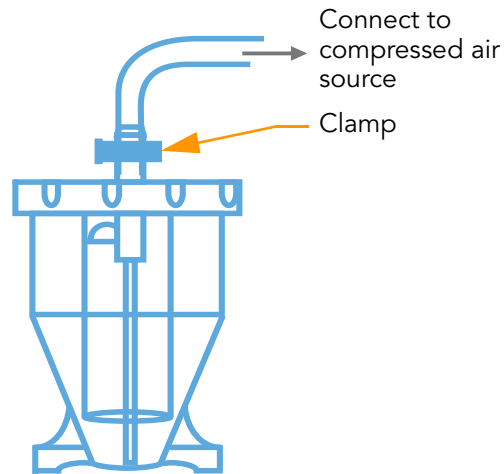

*Figure 5* Connect Compressed Air

8. Bury the nebulizer in an ice bucket and place it in a fume hood.
9. Use the regulator on the compressed air source to ensure the air is delivered at 32–35 psi.
10. Nebulize for 6 minutes. You may notice vapor rising from the nebulizer; this is normal.
11. Centrifuge the nebulizer at 450 xg for 2 minutes to collect the droplets from the side of the nebulizer.
12. If a centrifuge is not available, then use 2 ml of the binding buffer from the QIAquick PCR Purification Kit to rinse the sides of the nebulizer and collect the DNA solution at the base of the nebulizer.
13. Measure the recovered volume. Typically, you should recover 400–600  $\mu$ l.
14. Follow the instructions in the QIAquick PCR Purification Kit to purify the sample solution and concentrate it on one QIAquick column, eluting in 30  $\mu$ l of EB.

## Perform End Repair

This protocol converts the overhangs resulting from fragmentation into blunt ends, using T4 DNA polymerase and E. coli DNA polymerase I Klenow fragment. The 3' to 5' exonuclease activity of these enzymes removes 3' overhangs and the polymerase activity fills in the 5' overhangs.

### Consumables **Illumina-Supplied**

- ▶ T4 DNA ligase buffer with 10mM ATP
- ▶ dNTPs mix
- ▶ T4 DNA polymerase
- ▶ Klenow DNA polymerase
- ▶ T4 PNK
- ▶ Water

### User-Supplied

- ▶ QIAquick PCR Purification Kit (QIAGEN, part # 28104)

### Procedure

1. Prepare the following reaction mix:
  - DNA sample (30  $\mu$ l)
  - Water (45  $\mu$ l)
  - T4 DNA ligase buffer with 10mM ATP (10  $\mu$ l)
  - dNTP mix (4  $\mu$ l)
  - T4 DNA polymerase (5  $\mu$ l)
  - Klenow DNA polymerase (1  $\mu$ l)
  - T4 PNK (5  $\mu$ l)The total volume should be 100  $\mu$ l.
2. Incubate in the thermal cycler for 30 minutes at 20°C.
3. Follow the instructions in the QIAquick PCR Purification Kit to purify on one QIAquick column, eluting in 32  $\mu$ l of EB.

## Add 'A' Bases to the 3' End of the DNA Fragments

This protocol adds an 'A' base to the 3' end of the blunt phosphorylated DNA fragments, using the polymerase activity of Klenow fragment (3' to 5' exo minus). This prepares the DNA fragments for ligation to the adapters, which have a single 'T' base overhang at their 3' end.

### Consumables **Illumina-Supplied**

- ▶ Klenow buffer
- ▶ dATP
- ▶ Klenow exo (3' to 5' exo minus)

### User-Supplied

- ▶ MinElute PCR Purification Kit (QIAGEN, part # 28004)



**NOTE**

This protocol requires a QIAquick MinElute column rather than a normal QIAquick column.

### Procedure

1. Prepare the following reaction mix:
  - DNA sample (32  $\mu$ l)
  - Klenow buffer (5  $\mu$ l)
  - dATP (10  $\mu$ l)
  - Klenow exo (3' to 5' exo minus) (3  $\mu$ l)The total volume should be 50  $\mu$ l.
2. Incubate for 30 minutes at 37°C.
3. Follow the instructions in the MinElute PCR Purification Kit to purify on one QIAquick MinElute column, eluting in 10  $\mu$ l of EB.

## Ligate Adapters to DNA Fragments

This protocol ligates adapters to the ends of the DNA fragments, preparing them to be hybridized to a flow cell.

### Consumables

#### Illumina-Supplied

- ▶ DNA ligase buffer
- ▶ Illumina adapter oligo mix
- ▶ DNA ligase

#### User-Supplied

- ▶ QIAquick PCR Purification Kit (QIAGEN, part # 28104)

### Procedure

This procedure uses a 10:1 molar ratio of adapter to genomic DNA insert, based on a starting quantity of 5 µg of DNA before fragmentation. If you started with less than 5 µg, titrate the volume of adapter reagent accordingly to maintain the 10:1 ratio of DNA.

1. Prepare the following reaction mix:

- DNA sample (10 µl)
- DNA ligase buffer (25 µl)
- Adapter oligo mix (10 µl)
- DNA ligase (5 µl)

The total volume should be 50 µl.

2. Incubate for 15 minutes at room temperature.

3. Follow the instructions in the QIAquick PCR Purification Kit to purify on one QIAquick column, eluting in 30 µl of EB.

## Purify Ligation Products

This protocol purifies the products of the ligation reaction on a gel to remove all unligated adapters, remove any adapters that may have ligated to one another, and select a size-range of templates to go on the cluster generation platform.

### Consumables User-Supplied

- ▶ Certified low-range Ultra Agarose (BIO-RAD, part # 161-3106)
- ▶ 50x TAE buffer
- ▶ Distilled water
- ▶ Ethidium bromide
- ▶ Loading buffer (50 mM Tris pH 8.0, 40 mM EDTA, 40% (w/v) sucrose)
- ▶ Low molecular weight DNA ladder (NEB, part # N3233L)
- ▶ QIAquick or MinElute Gel Extraction Kit (QIAGEN, part # 28004)

### Procedure



Illumina does not recommend purifying multiple samples on a single gel due to the risk of cross-contamination between libraries.



It is important to perform this procedure exactly as described, to ensure reproducibility.



It is important to excise as narrow a band as possible from the gel during gel purification. Paired end libraries should consist of templates of the same size or nearly the same size.

1. Prepare a 50 ml, 2% agarose gel with distilled water and TAE. Final concentration of TAE should be 1X at 50 ml.
2. Add ethidium bromide (EtBr) after the TAE-agarose has cooled to avoid ethidium bromide inhalation. Final concentration of EtBr should be 400 ng/ml (i.e., add 20 µg EtBr to 50 ml of 1X TAE).
3. Add 3 µl of loading buffer to 8 µl of the ladder.
4. Add 10 µl of loading buffer to 30 µl of the DNA from the purified ligation reaction.
5. Load all of the ladder solution to one lane of the gel.

6. Load the entire sample in another lane of the gel, leaving at least a gap of one empty lane between ladder and sample.
7. Run the gel at 120 V for 60 minutes.
8. View the gel on a Dark Reader transilluminator, which is a safer alternative to a UV transilluminator.



Prolonged personnel exposure to UV light can damage your DNA.

9. Excise a region of gel with a clean scalpel. The gel slice should contain the material in the 150–200 bp range.



You can select more than one size-range of adapter-ligated DNA by excising slices from different parts of the gel. A relatively short insert template is 150–200 bp, while 300–650 bp is a long insert template.

10. Use a QIAGEN Gel Extraction Kit (QIAGEN, part # 28704) to purify the DNA from the agarose slices. If the gel slice is large, you may need two columns.
11. Using the MinElute Gel Extraction Kit (QIAGEN, part # 28604), do one of the following:
  - For one column, elute in 30  $\mu$ l EB.
  - For two columns, use the minElute columns, elute each one in 15  $\mu$ l EB, and pool.

## Enrich the Adapter-Modified DNA Fragments by PCR

This protocol uses PCR to selectively enrich those DNA fragments that have adapter molecules on both ends, and to amplify the amount of DNA in the library. The PCR is performed with two primers that anneal to the ends of the adapters. Only 18 cycles of PCR are employed, to avoid skewing the representation of the library.

### Consumables **Illumina-Supplied**

- ▶ Phusion\* DNA polymerase (Finnzymes Oy)
- ▶ PCR primer 1.1
- ▶ PCR primer 2.1
- ▶ Ultra pure water

### User-Supplied

- ▶ QIAquick PCR Purification Kit (QIAGEN, part # 28104)

### Procedure

1. Prepare the following PCR reaction mix:
  - DNA (1  $\mu$ l)
  - Phusion\* DNA polymerase (Finnzymes Oy) (25  $\mu$ l)
  - PCR primer 1.1 (1  $\mu$ l)
  - PCR primer 2.1 (1  $\mu$ l)
  - Water (22  $\mu$ l)The total volume should be 50  $\mu$ l.
2. Amplify using the following PCR protocol:
  - a. 30 seconds at 98°C
  - b. 18 cycles of:
    - 10 seconds at 98°C
    - 30 seconds at 65°C
    - 30 seconds at 72°C
  - c. 5 minutes at 72°C
  - d. Hold at 4°C
3. Follow the instructions in the QIAquick PCR Purification Kit to purify on one QIAquick column, eluting in 50  $\mu$ l of EB.

## Validate the Library

Illumina recommends performing the following quality control steps on your DNA library.

1. Determine the concentration of the library by measuring its absorbance at 260 nm. The yield from the protocol should be between 500 and 1000 ng of DNA.
2. Measure the 260/280 ratio. It should be approximately 1.8.
3. Load 10% of the volume of the library on a gel and check that the size range is as expected. It should be similar in size to the size-range excised during the gel purification step.
4. To determine the molar concentration of the library, examine the gel image and estimate the medium size of the library smear. This is generally about 450 bp for a long insert library and about 170 bp for a short insert library.
  - a. Multiply this size by 650 (the molecular mass of a base-pair) to get the molecular weight of the library.
  - b. Use this number to calculate the molar concentration of the library.
5. Clone 4% of the volume of the library into a sequencing vector.
  - a. Sequence individual clones by conventional Sanger sequencing.
  - b. Verify that the insert sequences are from the genomic source DNA.

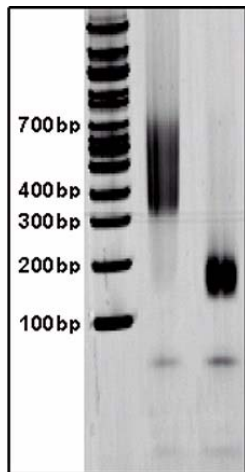

**Figure 6** Sequencing Gel

This example shows libraries that were run on a 4–20% TBE polyacrylamide gel. The gels were stained with Vistra Green (GE Healthcare #RPN5786) and visualized on a fluorescence scanner. The smear on the middle lane shows a long insert library, and the smear on the right shows a short insert library. The left lane shows a marker ladder. The two bands less than 100 bp in size in the middle and right lanes are primers from the enrichment PCR step and have no consequence for the subsequent formation of clusters.





Illumina, Inc.  
9885 Towne Centre Drive  
San Diego, CA 92121-1975  
+1.800.809.ILMN (4566)  
+1.858.202.4566 (outside North America)  
techsupport@illumina.com  
[www.illumina.com](http://www.illumina.com)

